Features

- APD with 1.0 mm² active area
- Slow multiplication curve
- QE > 80% @ 750 nm-910 nm
- Fast rise time, low noise
- Optimum gain: 50-60

Description

Circular active area APD chip with NIR enhanced sensitivity. Metal can type hermetic TO52 package with clear glass window.

Application

- Laser range finder
- High speed photometry
- High speed optical communications
- Medical equipment

RoHS

2002/95/EC

Absolute maximum ratings

Symbol	Parameter	Min	Max	Unit
T _{STG}	Storage temp	-55	125	°C
T _{OP}	Operating temp	-40	100	°C
M _{max}	Gain (I _{PO} = 1 nA)	200		
I _{PEAK}	Peak DC current		0.25	mA

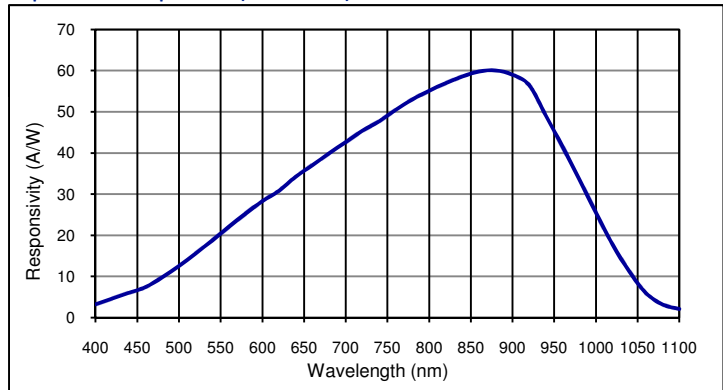
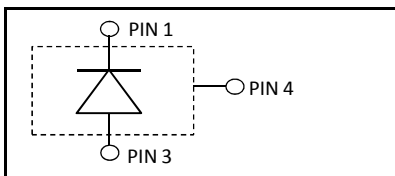
Spectral response (M = 100)

Schematic

Electro-optical characteristics @ 23 °C

Symbol	Characteristic	Test Condition	Min	Typ	Max	Unit
	Active area		diameter 1130			μm
	Active area		1.0			mm ²
I _D	Dark current	M = 100		4.0	10.0	nA
C	Capacitance	M = 100		3.0		pF
	Responsivity	M = 100; λ = 905 nm	52	58	60	A/W
t _R	Rise time	M = 100; λ = 905 nm; R _L = 50 Ω		1.3		ns
	Cut-off frequency	-3dB		0.3		GHz
V _{BR}	Breakdown voltage	I _R = 2 μA, V _{BR} - binning available	160	200	240	V
	Temperature coefficient	Change of V _{BR} with temperature	1.25		1.55	V/K
	Excess noise factor	M = 100		2.5		
	Excess noise index	M = 100		0.2		

European, International Sales:

First Sensor AG
 Peter-Behrens-Strasse 15
 12459 Berlin
 Germany
 T +49 30 6399 2399
 F +49 30 639923-752
 sales.opto@first-sensor.com

USA:

First Sensor Inc.
 5700 Corsa Avenue #105
 Westlake Village
 CA 91362 USA
 T +1 818 706 3400
 F +1 818 889 7053
 sales.us@first-sensor.com

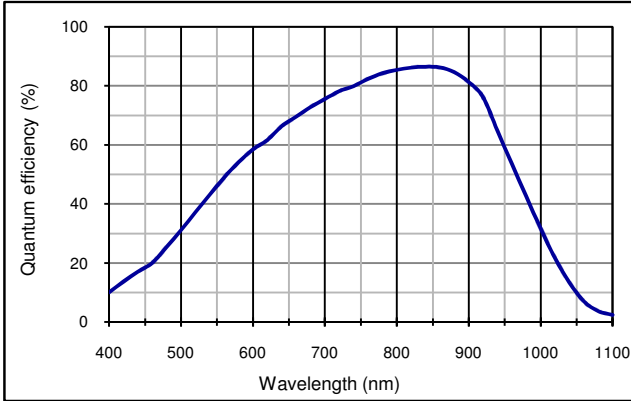
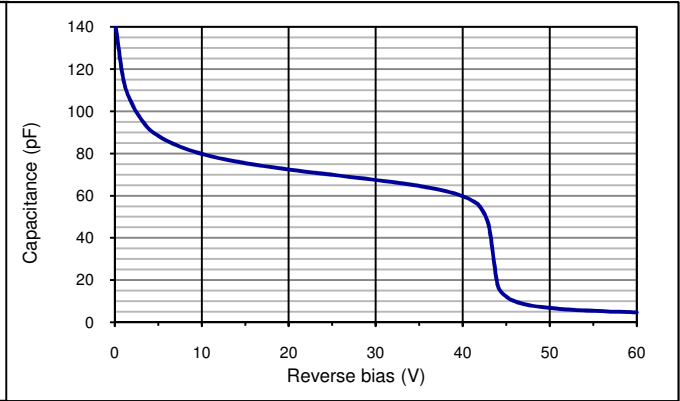
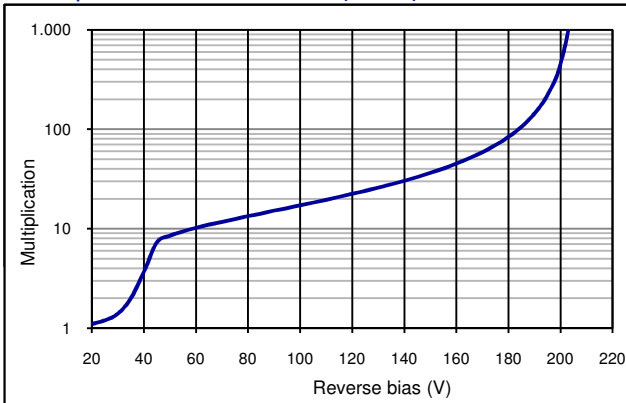
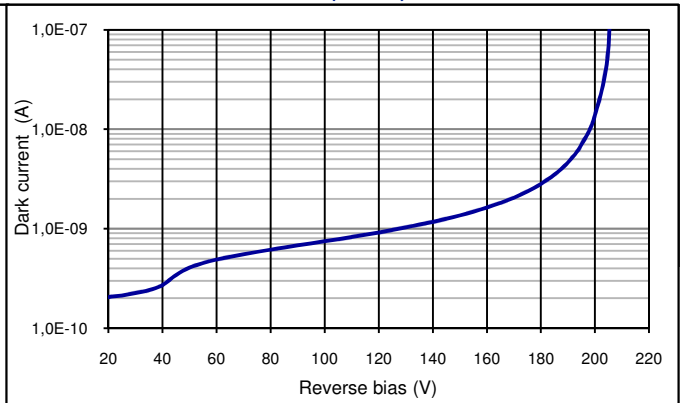
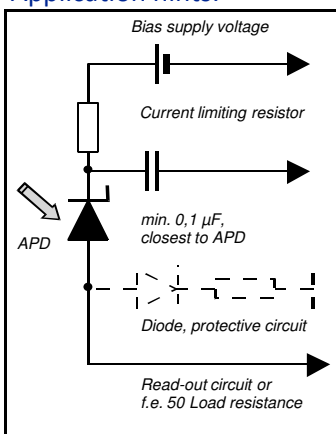
Quantum efficiency (23 °C)

Capacitance as fct of reverse bias (23 °C)

Multiplication as fct of bias (23 °C)

Dark current as fct of bias (23 °C)

Application hints:

- Current should be limited by a protecting resistor or current limiting - IC inside the power supply
- For low light level applications blocking of ambient light should be used
- For high gain applications bias voltage should be temperature compensated
- Please consider basic ESD protection while handling
- Use low noise read-out - IC
- For further questions please refer to document "Instructions for handling and processing"
- Optimum gain: 50-60

Package dimension:

Small quantities: Foam pad, boxed (12 cm x 16.5 cm)

Disclaimer: Due to our strive for continuous improvement, specifications are subject to change within our PCN policy according to JESD46C.

European, International Sales:

First Sensor AG
 Peter-Behrens-Strasse 15
 12459 Berlin
 Germany
 T +49 30 6399 2399
 F +49 30 639923-752
 sales.opto@first-sensor.com

USA:

First Sensor Inc.
 5700 Corsa Avenue #105
 Westlake Village
 CA 91362 USA
 T +1 818 706 3400
 F +1 818 889 7053
 sales.us@first-sensor.com